

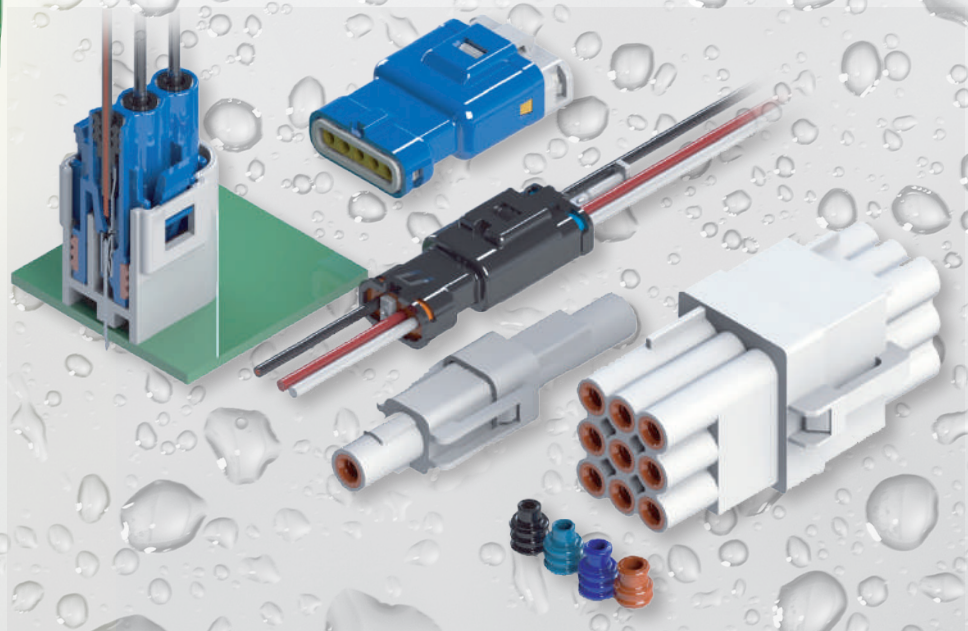

EDAC



WATERPROOF CONNECTORS



IP Rated Wire-to-Wire, Wire-to-Board

Connect with Us . . . Experience Makes the Difference

Series 560

Wire-to-Wire/Wire-to-Board 2.5mm pitch



- IP67 Certified
- 2.5mm pitch, rated current: 3A max
- Fully waterproof with Double Latch Solution
- Available in Wire-to-Wire and Wire-to-Board options
- Seals pre-assembled into housing; No external sealing required - available in 2, 3 or 5 positions
- Crimp and poke home contacts
- Waterproofing cap available to cover holes of wire seal
- Internal polarization to prevent mis-mating
- Available with wire already installed



Specifications	
No. of Positions	2, 3, 5P
Pitch	2.5mm
Rated Voltage	250V
Rated Current	3A max
Withstanding Voltage	1000V AC (rms)
Contact Resistance	15 mΩ max
Insulation Resistance	1000 MΩ min./DC500V
Temperature Range	-40°C to +105°C
PCB Thickness	1.6mm

Materials		
Crimp & Poke	Housing	PBT, UL 94V-0
	Contact	Phosphor Bronze
PCB Header	Housing	PBT with Glass, UL 94V-0
	Contact	Brass
Contact Plating	Tin Plating	
Wire & Housing Seals	Silicone Rubber	
Waterproofing Cap	PBT, UL 94V-0	

Waterproofing Cap	
Part No.	
565-200-100	

Crimp Contact			
Male Contact (Pin)			
Part No.	AWG#	Ins. Dia.	PCs/Reel
565-290-731	20-22	Max. Ø1.7	8,000
565-290-711	22-28	Max. Ø1.6	8,000

Crimp Contacts are also available in strips of 60pcs. Add P60 to the end of each contact part number.

Female Contact (Socket)			
Part No.	AWG#	Ins. Dia.	PCs/Reel
565-290-741	20-22	Max. Ø1.7	8,000
565-290-721	22-28	Max. Ø1.6	10,000

Wire seals, housing seals and retainers are already pre-assembled in the connector.

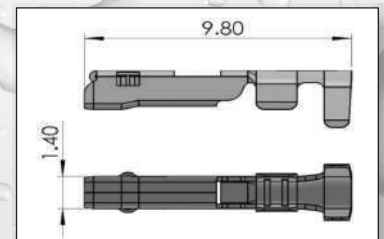
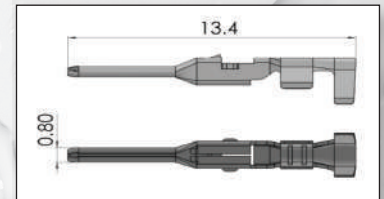

Rear Gasket (Wire Seal)		
Applicable Contact	Wire O.D.	Color
565-290-711	Ø1.00 to Ø1.30	Yellow
565-290-721	Ø1.30 to Ø1.70	Orange

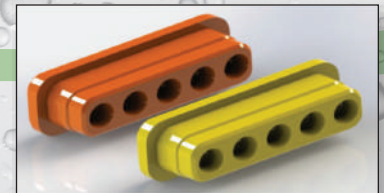

Ordering Code **560-002-000-110**

Series
560 – Wire-to-Wire
Wire-to-Board

No. of Contacts
002 – 2 contacts
003 – 3 contacts
005 – 5 contacts



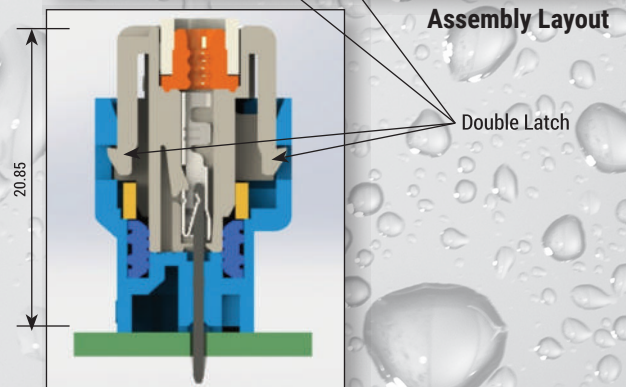
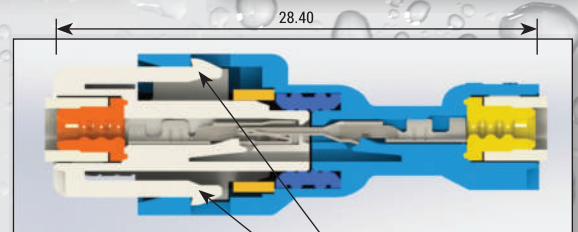

Contact Code
000 – No. Contacts (only for crimp contacts)
420 – Board mount contacts

Style
101 – White male housing (only for board mount contacts)
301 – Blue male housing (only for board mount contacts)
110 – White male housing for wire insulation Ø1.00 to Ø1.30
310 – Blue male housing for wire insulation Ø1.00 to Ø1.30
111 – White male housing for wire insulation Ø1.30 to Ø1.70
311 – Blue male housing for wire insulation Ø1.30 to Ø1.70
210 – White female housing for wire insulation Ø1.00 to Ø1.30
410 – Blue female housing for wire insulation Ø1.00 to Ø1.30
211 – White female housing for wire insulation Ø1.30 to Ø1.70
411 – Blue female housing for wire insulation Ø1.30 to Ø1.70



Quick Reference Guide



	Series	Pitch	Wire-to-PCB	Wire-to-Wire	No of Latches	Current	Voltage	Temperature	Approvals	Wire Gauges
	560	2.5	2,3,5	2,3,5	2	3A	250V	-40 to +105 °C	IP67	20-28AWG
	566	2	2,3,4,6	2,3	1	2A	250V	-40 to +105 °C	IP67	22-28AWG
	567	5 x 5.96	N/A	1,2,3,4,6,9	2	8A	300V	-40 to +105 °C	1P52	14-22AWG
	568	-	-	1	2	12A	300V	-40 to +105 °C	IP52	14-22AWG
	572	5.8	1,2,3	1,2,3	2	10A	300V	-40 to +105 °C	IP67	14-22AWG

- EDAC's Waterproof wire-to-wire & wire-to-PCB connectors have been designed for use in rugged and harsh environments including, automotive, recreational and commercial vehicles, outdoor lighting, marine, solar, industrial / process control, construction and outdoor broadcast applications.
- Contacts are supplied in reels and in strips of 40 or 60 pieces depending on series.
- Hand crimp tooling 565-280-210 is suitable for 560,567, 568, and 572 series.
- Contact removal tool 570-280-300 for 567, 568, & 572 series
- Contact removal tool 565-280-301 for 560 series connectors

**Custom assemblies are available in all series directly from EDAC, manufactured to your specifications.
Contact EDAC or your local representative for more information**

SERIES 566

Wire-to-Wire/Wire-to-Board 2.0mm pitch



- IP67 Certified
- 2.0mm pitch, rated current: 2A max
- Fully Waterproof Solution available in 2, 3, 4, or 6 positions (2 and 3 positions only for wire-to-board)
- Available in wire-to-wire and wire-to-board options
- Seals pre-assembled into housing; no external sealing required
- Crimp and Poke home contacts
- Waterproofing cap available to cover holes of wire seal
- Available with wire already installed



Specifications	
No. of Positions	2, 3, 4, or 6P
Pitch	2.0mm
Rated Voltage	250V
Rated Current	2A max
Withstanding Voltage	1000V AC (rms)
Contact Resistance	10 mΩ max
Insulation Resistance	1000 MΩ min./DC500V
Temperature Range	-40°C to +105°C
PCB Thickness	1.6mm

Crimp Contact			
Male Contact (Pin)			
Part No.	AWG#	Ins. Dia.	PCs/Reel
566-290-711	22-28	Ø1.0 - Ø1.5	12,000

Crimp Contacts are also available in strips of 60pcs.
Add P60 to the end of each contact part number.

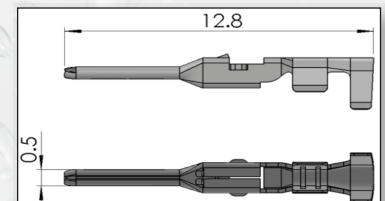

Female Contact (Socket)			
Part No.	AWG#	Ins. Dia.	PCs/Reel
566-290-721	22-28	Ø1.0 - Ø1.5	12,000

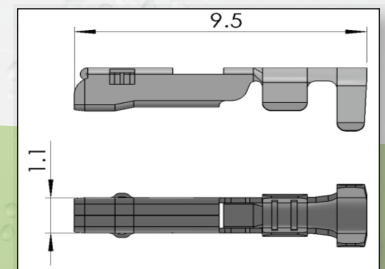

Materials		
Crimp & Poke	Housing	PBT, UL 94V-0
	Contact	Phosphor Bronze
PCB Header	Housing	PBT with Glass, UL 94V-0
	Contact	Brass
Contact Plating	Tin Plating	
Wire & Housing Seals	Silicone Rubber	
Waterproofing Cap	PBT, UL 94V-0	

Wire seals and housing seals are already pre-assembled in the connector.

Waterproofing Cap	
Part No.	
566-200-100	



Rear Gasket (Wire Seal)		
Applicable Contact	Wire O.D.	Color
566-290-711	Ø1.00 to Ø1.25	Light Blue
566-290-721	Ø1.25 to Ø1.50	Orange



Ordering Code

560-002-000-110

Series

566 - Wire-to-Wire
Wire-to-Board

No. of Contacts

002 - 2 contacts
003 - 3 contacts
004 - 4 contacts
006 - 6 contacts

Contact Code

000 - No. Contacts (only for crimp contacts)
421 - Board mount contacts (PCB) only for 2 & 3 pin size

Style

701 - Black male housing (only for board mount contacts)
710 - Black male housing for wire insulation Ø1.00 to Ø1.25
711 - Black male housing for wire insulation Ø1.25 to Ø1.50
810 - Black female housing for wire insulation Ø1.00 to Ø1.25
811 - Black female housing for wire insulation Ø1.25 to Ø1.25

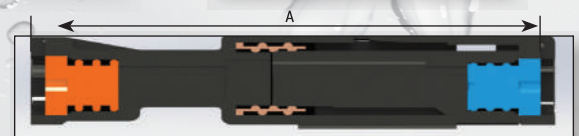

Assembly Layout

Pin Size	A (mm) Length
2P, 3P, 4P	28.85
6P	29.05

Waterproofing Cap

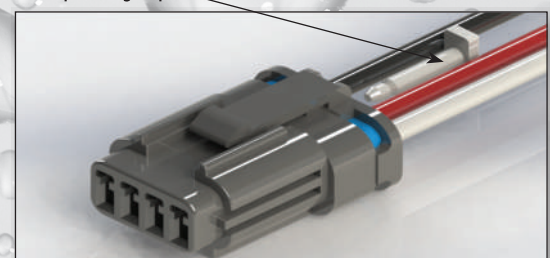

Note: Waterproofing Cap is installed at wire seal end to cover unused holes.

Series 567

Wire-to-Wire/Splash Proof 5.0 x 5.9mm Pitch

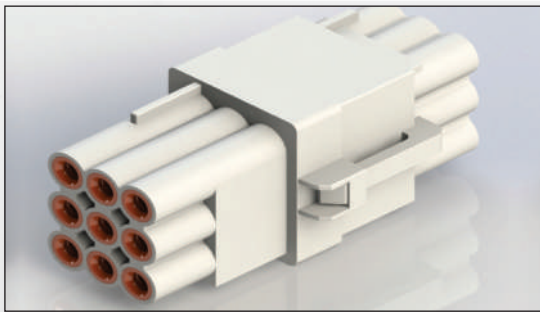

- IP52 (JIS C0920) Certified
- 5.0mm x 5.9mm pitch, rated current: 8A max
- Splash Proof solution available in 1,2, 3, 4, 6 or 9 positions
- Available in wire-to-wire options
- Crimp and poke home contacts with various sized wire seals available
- Available with wire already installed



Specifications	
No. of Positions	1,2, 3, 4, 6 or 9P
Pitch	5.0mm x 5.9mm
Rated Voltage	300V
Rated Current	8A max
Withstanding Voltage	1700V AC (rms)
Contact Resistance	10 mΩ max
Insulation Resistance	1000 MΩ min./DC500V
Temperature Range	-40°C to +105°C

Materials		
Crimp & Poke	Housing	PBT, UL 94V-0
	Contact	Phosphor Bronze or Brass
Contact Plating	Tin Plating	
Wire Seal	Silicone Rubber	

Wire Seal					
Part No.	Wire O.D.	Color	AWG#	Ø Dia	Height
570-260-001	Ø1.7 to Ø2.1	Black	22	Ø5.0	6.0
570-260-002	Ø2.1 to Ø2.7	Light Blue	22-20	Ø5.0	6.0
570-260-003	Ø2.1 to Ø2.7	Blue	22-20	Ø5.0	6.7
570-260-004	Ø2.7 to Ø3.1	Brown	20-14	Ø4.9	5.0

Crimp Contact				
Male Contact (Pin)				
Part No.	Material	AWG#	Ins. Dia.	PCs/Reel
570-290-751	(Brass)	14	Max Ø3.1	4,000
570-291-731	(Ph. Brz)	20-16	Max Ø3.1	4,000
570-290-731	(Brass)	20-16	Max Ø3.1	4,000
570-290-711	(Brass)	22-20	Max Ø2.7	4,000

Female Contact (Socket)				
Part No.	Material	AWG#	Ins. Dia.	PCs/Reel
570-290-761	(Brass)	14	Max Ø3.1	4,000
570-291-741	(Ph. Brz)	20-16	Max Ø3.1	4,000
570-290-741	(Brass)	20-16	Max Ø3.1	4,000
570-291-721	(Ph. Brz)	22-20	Max Ø2.7	4,000
570-290-721	(Brass)	22-20	Max Ø2.7	4,000

Crimp Contacts are also available in strips of 40pcs.
Add P40 to the end of each contact part number.

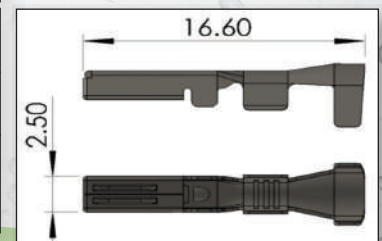
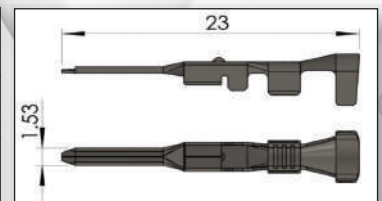

Ordering Code **567-002-000-100**

Series
567 - Wire-to-Wire

No. of Contacts
001 - 1 Contact
002 - 2 Contacts
003 - 3 Contacts
004 - 4 Contacts
006 - 6 Contacts
009 - 9 Contacts

Contact Code
000 - No. Contacts (only for crimp contacts)

Style
310 - White male housing for crimp contacts
410 - White female housing for crimp contacts

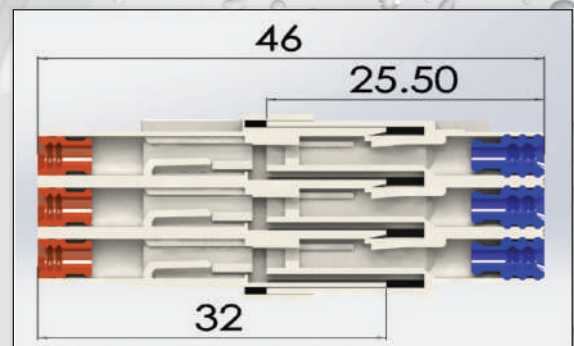

Assembly Layout

Series 568

Wire-to-Wire/Splash Proof

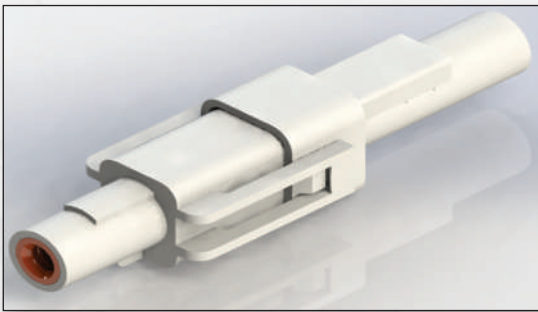

- IP52 (JIS C0920) Certified
- Rated current 12A max
- Splash Proof solution for single position
- Available in wire-to-wire option
- True crimp and poke solution with various sized wire seals available
- Available with wire already installed



Specifications	
Rated Voltage	300V
Rated Current	12A max
Withstanding Voltage	1700V AC (rms)
Contact Resistance	10 mΩ max
Insulation Resistance	1000 MΩ min./DC500V
Temperature Range	-40°C to +105°C

Materials		
Crimp & Poke	Housing	PBT, UL 94V-0
	Contact	Phosphor Bronze or Brass
Contact Plating	Tin Plating	
Wire Seal	Silicone Rubber	

Crimp Contact				
Male Contact (Pin)				
Part No.	Material	AWG#	Ins. Dia.	PCs/Reel
570-290-751	(Brass)	14	Max Ø3.1	4,000
570-291-731	(Ph. Brz)	20-16	Max Ø3.1	4,000
570-290-731	(Brass)	20-16	Max Ø3.1	4,000
570-290-711	(Brass)	22-20	Max Ø2.7	4,000

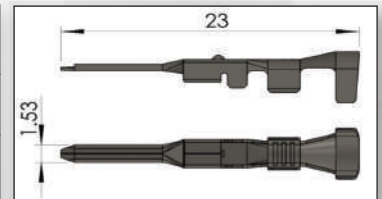

Female Contact (Socket)				
Part No.	Material	AWG#	Ins. Dia.	PCs/Reel
570-290-761	(Brass)	14	Max Ø3.1	4,000
570-291-741	(Ph. Brz)	20-16	Max Ø3.1	4,000
570-290-741	(Brass)	20-16	Max Ø3.1	4,000
570-291-721	(Ph. Brz)	22-20	Max Ø2.7	4,000
570-290-721	(Brass)	22-20	Max Ø2.7	4,000

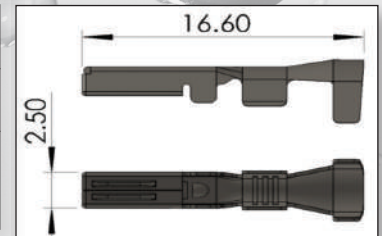

Crimp Contacts are also available in strips of 40pcs.
Add P40 to the end of each contact part number.

Wire Seal					
Part No.	Wire O.D.	Color	AWG#	Ø Dia	Height
570-260-001	Ø1.7 to Ø2.1	Black	22	Ø5.0	6.0
570-260-002	Ø2.1 to Ø2.7	Light Blue	22-20	Ø5.0	6.0
570-260-003	Ø2.1 to Ø2.7	Blue	22-20	Ø5.0	6.7
570-260-004	Ø2.7 to Ø3.1	Brown	20-14	Ø4.9	5.0



Ordering Code

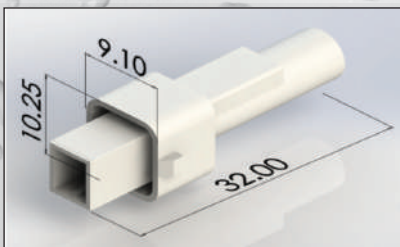

568-001-000-100

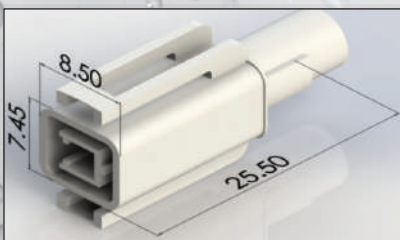

568-001-000-200

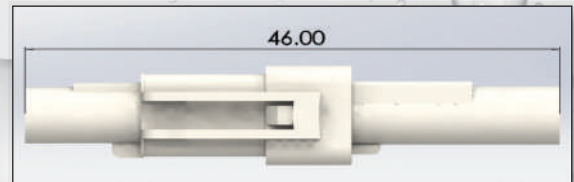

Assembly Layout

Series 572 Wire-to-Wire/Wire-to-Board 5.8mm pitch

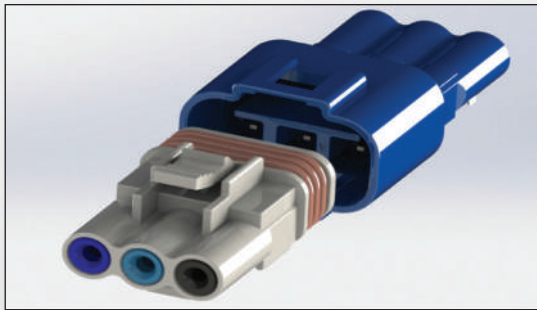

- IP67 Certified
- 5.8mm pitch, rated current 10A max
- Fully waterproof with double latch solution
- Available in wire-to-wire and wire-to-board options
- Seals pre-assembled into housing; no external sealing required. Available in 1, 2 or 3 Positions
- Crimp and poke home contacts
- Internal polarization to prevent mis-mating
- Available with wire already installed
- Wide range of wire sizes available



Specifications	
No. of Positions	1, 2, 3P
Pitch	5.8mm
Rated Voltage	300V
Rated Current	10A max
Withstanding Voltage	1700V AC (rms)
Contact Resistance	10 mΩ max
Insulation Resistance	1000 MΩ min./DC500V
Temperature Range	-40°C to +105°C
PCB Thickness	1.6mm

Materials		
Crimp & Poke	Housing	PBT, UL 94V-0
	Contact	Ph, Brz, or Brass
PCB Header	Housing	PBT with Glass, UL 94V-0
	Contact	Brass
Contact Plating	Tin Plating	
Wire & Housing Seals	Silicone Rubber	

Wire Seal					
Part No.	Wire O.D.	Color	AWG#	Ø Dia	Height
570-260-001	Ø1.7 to Ø2.1	Black	22	Ø5.0	6.0
570-260-002	Ø2.1 to Ø2.7	Light Blue	22-20	Ø5.0	6.0
570-260-003	Ø2.1 to Ø2.7	Blue	22-20	Ø5.0	6.7
570-260-004	Ø2.7 to Ø3.1	Brown	20-14	Ø4.9	5.0

Crimp Contact				
Male Contact (Pin)				
Part No.	Material	AWG#	Ins. Dia.	PCs/Reel
570-290-751	(Brass)	14	Max Ø3.1	4,000
570-291-731	(Ph. Brz)	20-16	Max Ø3.1	4,000
570-290-731	(Brass)	20-16	Max Ø3.1	4,000
570-290-711	(Brass)	22-20	Max Ø2.7	4,000

Female Contact (Socket)				
Part No.	Material	AWG#	Ins. Dia.	PCs/Reel
570-290-761	(Brass)	14	Max Ø3.1	4,000
570-291-741	(Ph. Brz)	20-16	Max Ø3.1	4,000
570-290-741	(Brass)	20-16	Max Ø3.1	4,000
570-291-721	(Ph. Brz)	22-20	Max Ø2.7	4,000
570-290-721	(Brass)	22-20	Max Ø2.7	4,000

Crimp Contacts are also available in strips of 40pcs.
Add P40 to the end of each contact part number.

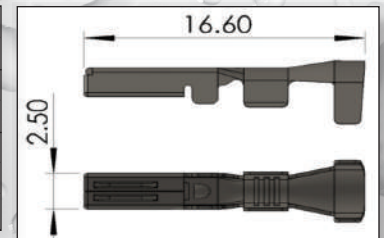
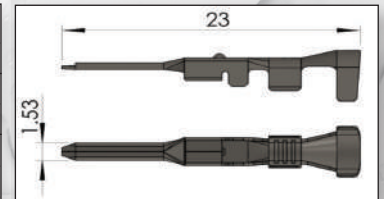

570-260-002

570-260-004

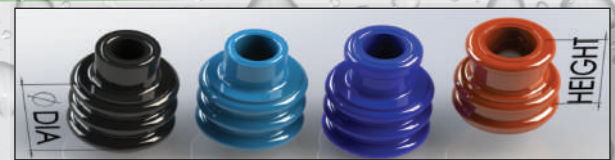

570-260-001

570-260-003
47.0

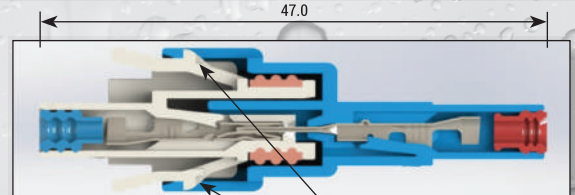

Assembly Layout

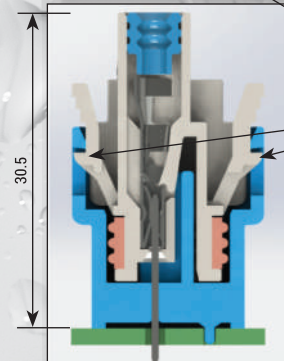

Double Latch

Ordering Code

572-002-000-100

Series

572 - Wire-to-Wire
Wire-to-Board

No. of Contacts

001 - 1 contact
002 - 2 contacts
003 - 3 contacts
005 - 5 contacts

Contact Code

000 - No. Contacts (only for crimp contacts)
420 - Board mount contacts

Style

101 - White male housing (only for board mount contacts)
301 - Blue male housing (only for board mount contacts)
100 - White male housing for crimp contacts
300 - Blue male housing for crimp contacts
200 - White female housing for crimp contacts
400 - Blue female housing for crimp contacts



EDAC

North & South America
EDAC Inc.

Tel: +1 (0)416 754 3322
email: customerservice@edac.net

Europe, Middle East, Russia & Africa
EDAC (Europe) Ltd.

Tel: +44 (0)1933 427300
email: eu.enquiries@eu.edac.net

Our Capabilities

EDAC has been designing and manufacturing interconnect products for over 53 years. Today, EDAC supplies a wide variety of products to customers globally. We understand our markets and provide off-the-shelf and customized products manufactured to the highest quality standards.

Whether your requirements are fully custom, semi-custom, enhanced, or you need to replace an end of life part, we are dedicated to solving problems and supplying solutions to ensure you get the right product for your application. Our Experience Makes the Difference.



www.edac.net

Connect with Us . . . Experience Makes the Difference